

SECTION A

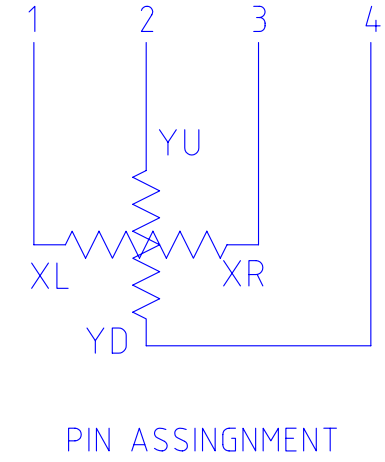
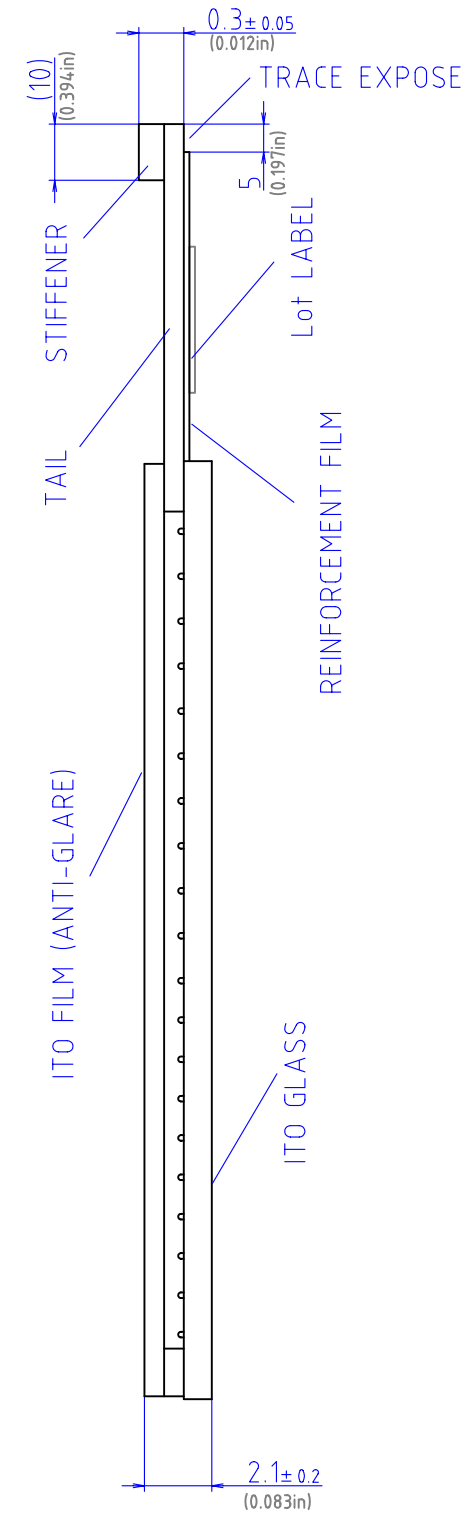
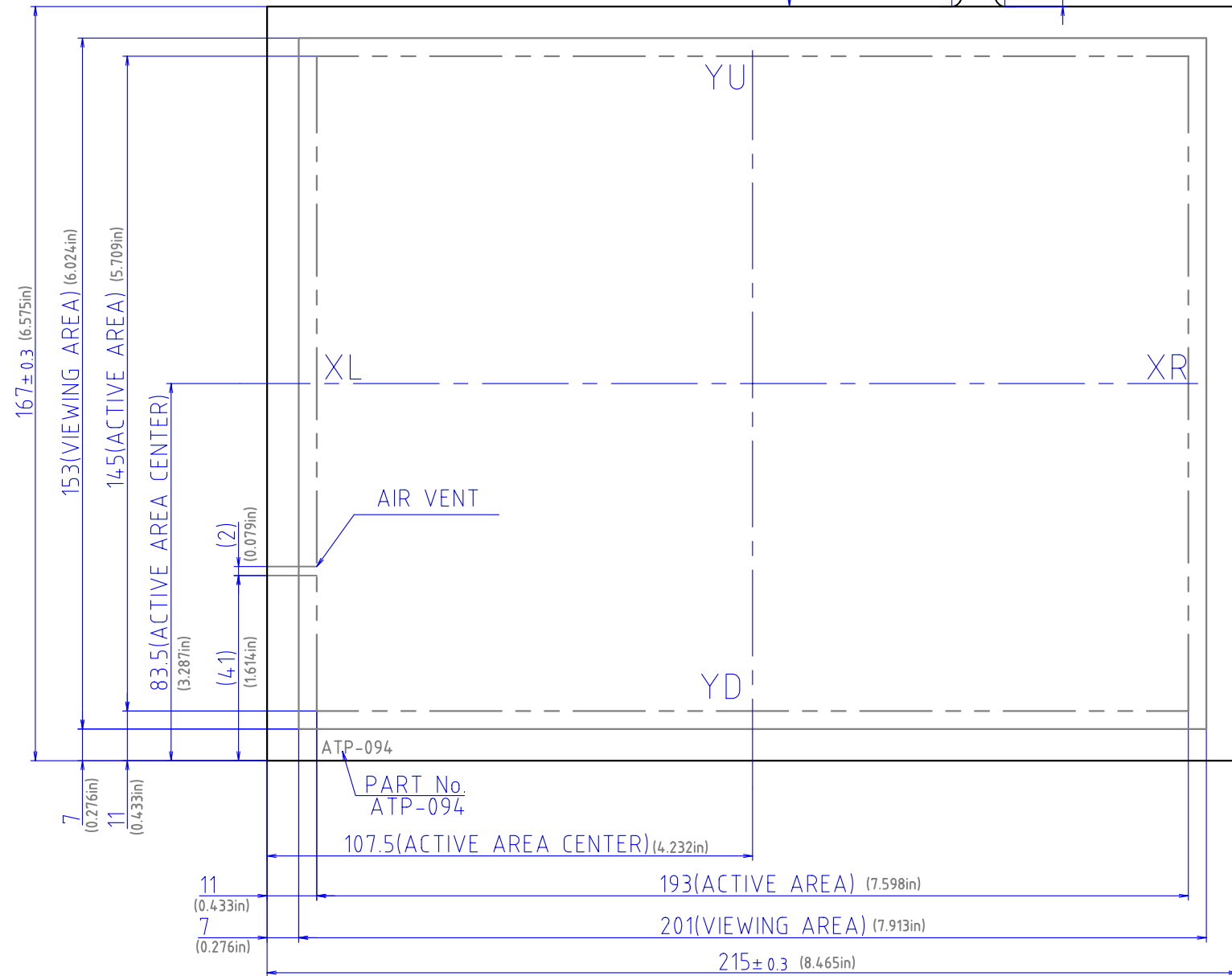
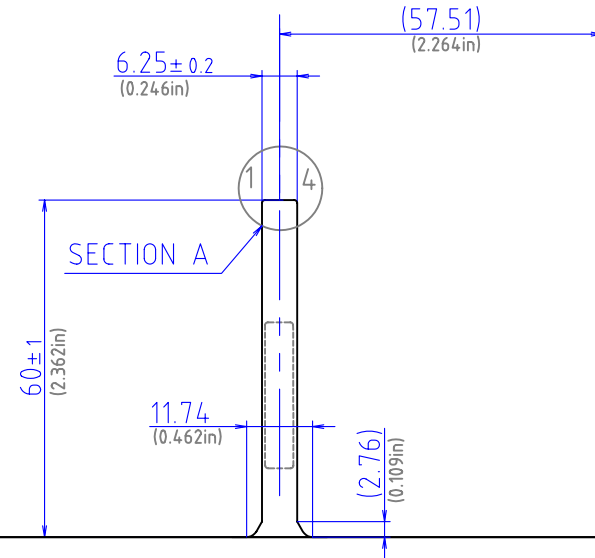
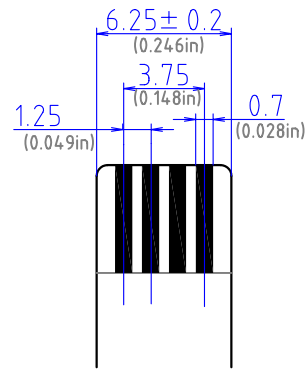

Tolerance ± 0.5
Unit=mm

PART	DATE
ATP-094	2003.03.15
TYPE	DMC Co., Ltd.
STANDARD TOUCHSCREEN DIMENSIONAL DRAWING	